

2" Horizontals

Product Information	B1-B3
Color Charts	B3-B4
Decorative Tape	B5
Motorization	B6
Pricing Charts	B7-B11
Samples	B11
Measuring Instructions	B12
Install Instructions	B13
Warranty	B14
Parts & Pieces	Reference

Product Information

2" Horizontals

Standard Shade Includes

Aluminum 2"

- 1 Slat Matching Valance
- Wand Tilt
- Left Tilt Control and Right Lift Control
- Shades 51 7/8" and under; 2 Brackets. For Shades 52" to 90"; 2 Brackets & 1 Center Support Bracket. For shades 90" and over; 2 Brackets & 2 Center Support Brackets.

Cascadia 2 1/2"

- Matching Royal Valance
- Wand Tilt
- Left Tilt Control and Right Lift Control
- Shades 51 7/8" and under; 2 Brackets. For Shades 52" to 90"; 2 Brackets & 1 Center Support Bracket. For shades 90" and over; 2 Brackets & 2 Center Support Brackets.

Sophistique 2" & 2 1/2"

- 1 Slat Matching Valance
- Cord Tilt
- Left Tilt Control and Right Lift Control
- Shades 42" and under; 2 Brackets. For Shades 42 1/2" and over; 2 Brackets and 1 Center support.

Olympic Woods 2" & 2 1/2"

- Matching Royal Valance
- Wand Tilt
- Left Tilt Control and Right Lift Control
- Shades 51 7/8" and under; 2 Brackets. For Shades 52" to 90"; 2 Brackets & 1 Center Support Bracket. For shades 90" and over; 2 Brackets & 2 Center Support Brackets.

Summit Woods 2" & 2 1/2"

- Matching Royal Valance
- Wand Tilt
- Left Tilt Control and Right Lift Control
- Shades 51 7/8" and under; 2 Brackets. For Shades 52" to 90"; 2 Brackets & 1 Center Support Bracket. For shades 90" and over; 2 Brackets & 2 Center Support Brackets.

Finished Dimensions

Inside Mount

Finished Width -1/2"

Outside Mount

Finished Width Exact Measurement Provided

Multiple Shades 1 Headrail

Gap between shades ±1/4"

Mounting Requirements

Aluminum

Inside minimum mounting depth 1 1/2"

Inside minimum mounting depth, flush mount * 2 3/4"

Outside minimum for flat surface 1/2"

Cascadia (Faux) 2 1/2"

Inside minimum mounting depth 1 1/2"

Inside minimum mounting depth, flush mount * 2 3/4"

Outside minimum for flat surface 1/2"

Sophistique (Soft Shades) 2" & 2 1/2"

Inside minimum mounting depth 1 1/2"

Inside minimum mounting depth, flush mount * 2 3/4"

Outside minimum for flat surface 1"

Olympic Woods (Faux) 2" & 2 1/2"

Inside minimum mounting depth 1 1/2"

Inside minimum mounting depth, flush mount * 2 3/4"

Outside minimum for flat surface 1/2"

Summit Woods (Bass Wood) 2" & 2 1/2"

Inside minimum mounting depth 1 1/2"

Inside minimum mounting depth, flush mount * 2 3/4"

Outside minimum for flat surface 1/2"

* Flush mount refers to the headrail and does include the valance

Upgrades and Surcharges

Description	Additional Cost	Description	Additional Cost
Privacy Option	Add 10%	Multi-Colored - Each Additional Color	59
Blind Width Under 10"	87	2 on 1 Headrail	206
Wand Length 96" or greater	102	3 on 1 Headrail	263
1 1/2" Decorative Cloth Tape	Add 15%	Notch- 6" or Less	145
Multi-Colored - First Color	131	Angled	70
Cordless (49" and Under)	161	Cordless (49"-72")	312

Stack Chart

Drop	Aluminum	Cascadia	Lantex	Olympic Ridge	Summit Woods
36"	4 1/2"	5 3/8"	4 5/8"	5"	6 1/2"
48"	4 5/8"	6"	5 3/8"	6"	7"
54"	4 3/4"	6 3/8"	N/A	6 1/2"	7 1/2"
60"	5 1/8"	6 7/8"	6"	7"	8"
66"	5 1/2"	7 1/8"	N/A	7 1/2"	8 1/2"
72"	5 3/8"	7 1/2"	6 1/4"	8"	9"
78"	5 1/2"	7 7/8"	N/A	8 1/2"	9 1/2"
84"	5 5/8"	8 1/4"	7 3/8"	9"	10"
90"	5 3/4"	8 3/4"	N/A	9 1/2"	10 1/2"
96"	5 7/8"	8 7/8"	8 1/8"	10"	11"
120"	6 1/2"	10 1/8"	9 1/2"	12"	13"

All stack measurements include the headrail.

2" Collections



Aluminum



Cascadia



Summit Woods



Sophistique



Olympic Ridge

All of our corded 2" Horizontals feature:

- Crash-proof cord lock

Our Aluminum Collection features:

- Break-away safety tassels

2" Horizontals

Control Options

Not all control options are available in every collection. Please refer to the Quick Option Guide on page B3.



Wand Tilt



Cord Tilt



Motorized Tilt



Cordless Lift

Valance Options

Faux Valance will be split at lengths over 107".



Matching Slat
1 or 2 Slats
Aluminum &
Designer Vinyl

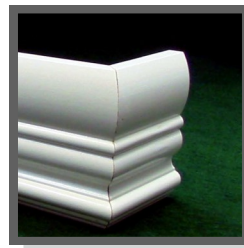

Royal Valance
Olympic Ridge



Royal Valance
Summit Woods



Crescent Valance
Olympic Ridge



Crescent Valance
Summit Woods

Miscellaneous Options



Sophistique
Valance

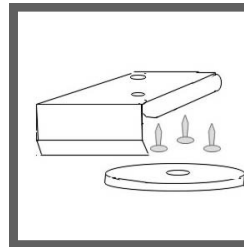

Magnet
Valance Clip

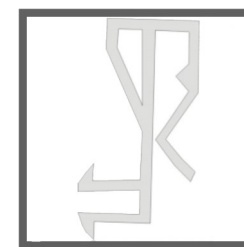

Hidden
Valance Clip

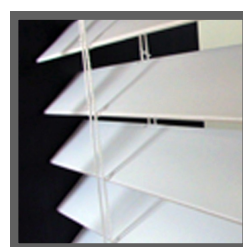

Privacy

Product Information

Minimums & Maximums

2" Horizontals

	Aluminum				Cascadia				Sophistique			
	Width (inches)		Drop (inches)		Width (inches)		Drop (inches)		Width (inches)		Drop (inches)	
	Min	Max	Min	Max	Min	Max	Min	Max	Min	Max	Min	Max
Tilt Only (Center of HR)	8	122	6	120*	8	108	6	120*	10	96	10	120
Split Controls (L/R or R/L)	9 1/4	122	6	120*	9 1/4	108	6	120*	10	96	10	120
Same Side (L/L or R/R)	16 1/8	122	6	120*	16 1/8	108	6	120*	10	96	10	120
2 on 1 Head Rail	16 1/8	144	6	120*	16 1/8	144	6	120*	10	96	10	120
3 on 1 Head Rail	16 1/8	144	6	120*	16 1/8	144	6	120*	N/A	N/A	N/A	N/A
Cordless	16	72	10	78	16	72	10	78	16	72	10	78
Maximum Sq. Ft.	122 square feet				120 square feet				80 square feet			

*Warranty restricted to blinds made within published limits

	Olympic Ridge				Summit Woods			
	Width (inches)		Drop (inches)		Width (inches)		Drop (inches)	
	Min	Max	Min	Max	Min	Max	Min	Max
Tilt Only (Center of HR)	8	108	6	120*	8	120	6	120*
Split Controls (L/R or R/L)	9 1/4	108	6	120*	9 1/4	120	6	120*
Same Side (L/L or R/R)	16 1/8	108	6	120*	16 1/8	120	6	120*
2 on 1 Head Rail	16 1/8	144	6	120*	16 1/8	144	6	120*
3 on 1 Head Rail	16 1/8	144	6	120*	16 1/8	144	6	120*
Cordless	16	72	10	78	16	72	10	78
Maximum Sq. Ft.	45 square feet				45 square feet			

*Warranty restricted to blinds made within published limits

Quick Options Guide

	Aluminum Standard	Cascadia 2 1/2" Beveled (Faux)	Sophistique (Soft Shade)	Sophistique 2 1/2" (Soft Shade)	Olympic Ridge (Faux)	Olympic Ridge 2 1/2" (Faux)	Summit Woods (Basswood)	Summit Woods 2 1/2" (Basswood)
Item Code	A2	B25	LX2	LX2	T2	T2	WB	WB
Wand Tilt	Yes	Yes			Yes	Yes	Yes	Yes
Cord Tilt	Yes	Yes			Yes	Yes	Yes	Yes
Motorization Tilt	Yes	Yes	No	No	Yes	Yes	Yes	Yes
Motorization Tilt & Lift	Yes		No	No	Yes	Yes	Yes	Yes
Decorative Cloth Tape	Yes	No	Standard	Standard	Yes	No	Yes	Yes
Privacy	No	Yes	Yes	Yes	Yes	Yes	Yes	No
Side Cut-Out	Yes	Yes	No	No	Yes	Yes	Yes	Yes
Side Bottom Cut-Out	Yes	Yes	No	No	Yes	Yes	Yes	Yes
Angled	Yes	Yes	No	No	Yes	Yes	Yes	Yes

Color Charts

Aluminum 2"

Item Code - A2

Style	Colors	ID	Chart	Style	Colors	ID	Chart
	Organza	A2004	A		Coffee	A2032	A
	Silk Clouds	A2005	A		Tornado	A2033	A
	Snowcap	A2007	A		Beige	A2037	A
	Pearl	A2013	A		Fairway	A2042	A
	Dusty Rose	A2015	A		True White	A2043	A
	Almost White	A2016	A				
	Alabaster	A2022	A				
	Brushed Aluminum	A2026	A				
	Linen Paper	A2028	A				
	Dark Skies	A2030	A				

Sophistique 2" & 2 1/2" - Soft Shades

Item Code - LX2

Style	Colors	ID	Chart
2" Solid	White	50100	H
2" Solid	Off White	50113	H
2" Solid	Vanilla	50125	H
2" Solid	Baby Pink	50203	H
2" Solid	Peach	50206	H
2" Solid	Pink	50215	H
2" Solid	Country Road	20295	H
2" Solid	Pecan	50334	H
2" Solid	Praline	50357	H
2" Solid	Cocoa	50378	H
2" Solid	Wheat	50430	H
2" Solid	Celadon	50503	H
2" Solid	Moss	50504	H
2" Solid	Provence Blue	50627	H
2" Solid	Grey	50823	H
2" Solid	Black	50897	H

Style	Colors	ID	Chart
2" Duo	White/Black	50100J897	H
2" Duo	Peach/Black	50206J897	H
2" Duo	Praline/Black	50357J897	H
2" Duo	Canary/Black	50417J897	H
2" Duo	Wheat/Buck	50430J897	H
2" Duo	Blue Ice/Black	50601J897	H
2" Wood	Pecan	50334-I	H
2" Wood	Maple	50430-I	H
2 1/2" Solid	White	65100	I
2 1/2" Solid	Off White	65113	I
2 1/2" Solid	Vanilla	65125	I
2 1/2" Solid	Peach	65206	I
2 1/2" Solid	Pecan	65334	I
2 1/2" Solid	Praline	65357	I
2 1/2" Solid	Cocoa	65378	I
2 1/2" Solid	Grey	65823	I

Olympic Ridge 2" & 2 1/2" - Faux Wood

Item Code - T2

Style	Colors	ID	Chart	2 1/2"
Whites	Snow White	200	B	
Whites	Bright White	201	B	D
Whites	White	203	B	D
Whites	Pearl	206	B	
Whites	Oyster	210	B	D
Whites	Off White	213	B	
Color	Grey Skies	260	C	
Color	Pebble	261	C	
Color	Granite	262	C	
Stains	Natural	251	C	
Stains	Maple	252	C	
Stains	Pecan	253	C	
Stains	Oak	254	C	E
Stains	Chestnut	256	C	

Style	Colors	ID	Chart	2 1/2"
Embossed	Snow White	200(e)	C	
Embossed	Pearl	206(e)	C	
Embossed	Oyster	210(e)	C	
Embossed	Off White	213(e)	C	
Stains	Mahogany	257	C	
Stains	Teak	258	C	E
Stains	Walnut	259	C	
Stains	Bleached Sand	411	C	E
Stains	Bourbon	428	C	E
Stain	Shadow	263	C	
Stain	Shale Rock	264	C	

Summit Woods 2" & 2 1/2" - Bass Wood

Item Code - WB

Style	Colors	ID	Chart
Whites	Vivid White *	1104	F
Whites	Alabaster	1123	F
Whites	Blanco *	1124	F
Whites	Bone *	2910	F
Stains	Cherry Wood	202	G
Stains	Mahogany	203	G
Stains	Dark Mahogany	205	G
Stains	Natural	1107	G
Stains	Sugar Maple	1109	G

* Available in 2 1/2"+ 20% Surcharge

Style	Colors	ID	Chart
Stains	Sunrise Oak	1111	G
Stains	Mink *	1112	G
Stains	Evening Oak *	1115	G
Stains	Cherry	1116	G
Stains	Bourbon	1120	G
Stains	Toasted Walnut *	1121	G
Stains	Warm Chestnut	1122	G
Stains	Kona *	1125	G
Stains	Merlot *	4001	G

* Available in 2 1/2"+ 20% Surcharge

2" Horizontals

Decorative Tape

2" Horizontals

1 1/2" Decorative Cloth Tape 24 Color Sku's

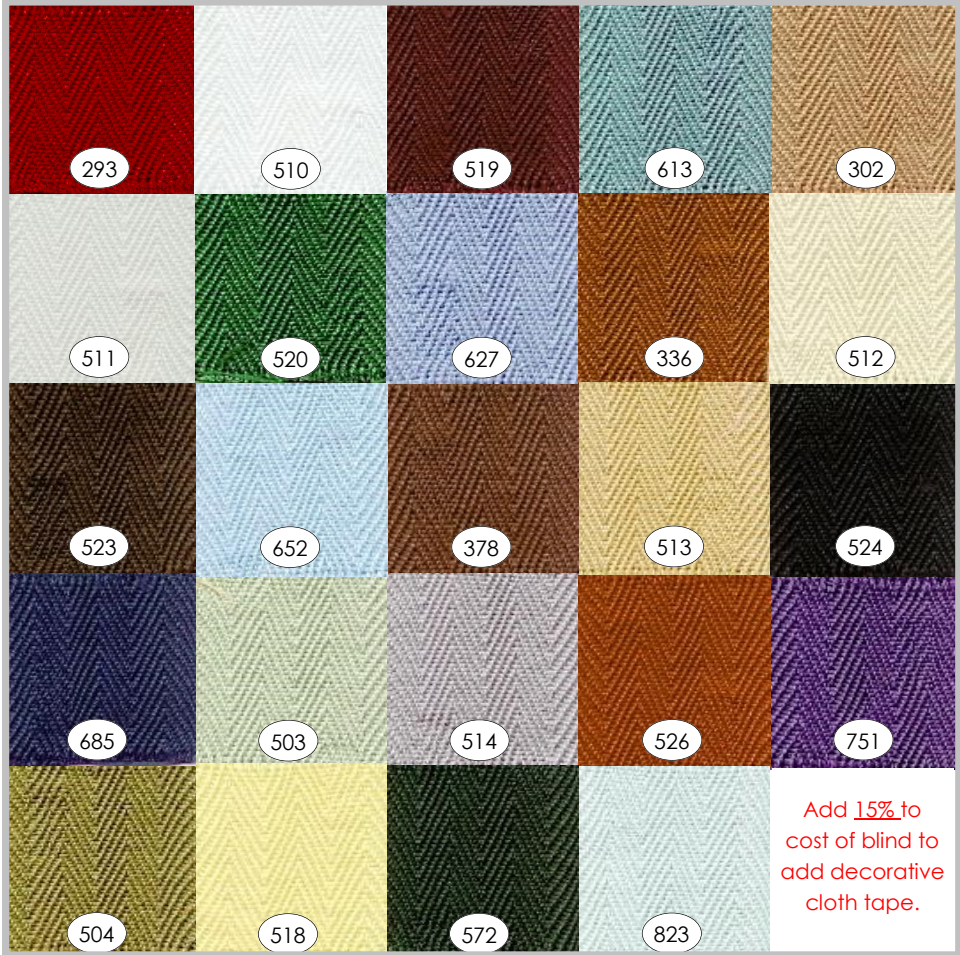

Fabric subject to dye lot variation. This photo is for reference only, please contact a sales representative for actual samples.

Color No.	Color Name
293	Crimson
302	Taupe
336	Light Brown
378	Dark Brown
503	Dusty Mint
504	Olive Green
510	Snow White
511	White
512	Light Tan
513	Buckwheat
514	Dark Gray
518	Light Canary
519	Deep Maroon
520	Emerald Green
523	Dark Charcoal Brown
524	Black
526	Deep Crimson Red
572	Deep Forest Green
613	Dark Aqua Blue
627	Virgil Blue
652	Sky Blue
685	Navy
751	Purple Grape
823	Light Gray

1/4" Sophistique Decorative Cloth Tape 16 Color Sku's

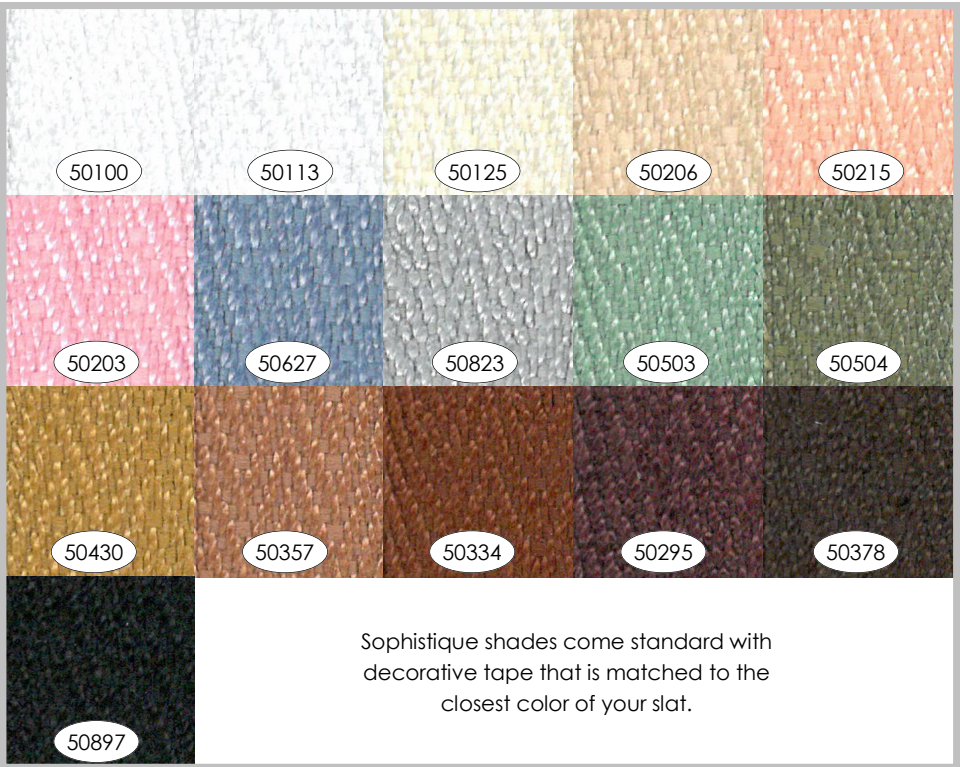

Fabric subject to dye lot variation. This photo is for reference only, please contact a sales representative for actual samples.

Color No.	Color Name
50100	White
50113	Off White
50125	Vanilla
50206	Peach
50215	Pink
50203	Baby Pink
50627	Provence Blue
50823	Grey
50503	Celadon
50504	Moss
50430	Wheat
50357	Praline
50334	Pecan
50295	Country Redwood
50378	Cocoa
50897	Black

How Motorize your 2" Shade with **somfy**®:

Step #1. Motor Choice

- Must have one motor for every shade

Step #2. Power Options

- Must have one power option for every shade

Step #3. Control Options

- Must have a minimum of 1 user interface option

1. Motor Choice

Tilt Motor 12v

\$105

2. Power Options

12V Reloadable Battery Tube	12V DC Plug in Transformer	Solar Pack
\$55	\$95	\$130

3. Control Options

Telis Modulis 1 Channel (scroll wheel for tilting)	Telis Modulis 4 Channel (scroll wheel for tilting)	MyLink Wi-Fi Controller	Home Automation
\$50	\$65	\$165	Call for pricing



Please be aware that the heavier the shade the slower your motor will work. It may also burn out the battery quicker.

2" Horizontals

Power Options



Solar Pack



Reloadable Battery Tube



DC Plug in Transformer

Accessories



Sunis Sun sensor



Thermo Sunis Temperature and sun sensor

Control Options



Telis Modulis 4 Channel



MyLink Wi-Fi Controller

Work up Sheet for Somfy 2" Horizontal Motorization:

		Cost	x	No. of Blinds	=	Total Cost
1	Motor Choice:					
2	Power Option Choice:					
3	User Interface Option Choice:					
Add up the totals and enter here for total cost:						

Pricing Charts

2" Horizontals

Chart A		Aluminum - Item Code A2																		
WIDTH TO:	23"	26"	29"	32"	36"	40"	44"	48"	52"	57"	62"	67"	72"	82"	92"	102"	112"	122"	Wand	Cord
42"	367	385	426	489	540	627	707	768	813	888	942	1009	1089	1187	1351	1451	1595	1725	24"	17"
48"	413	435	525	581	638	733	813	899	930	1001	1096	1165	1226	1384	1546	1652	1840	1965	24"	19"
54"	461	489	564	629	724	809	910	1001	1053	1126	1213	1271	1384	1546	1736	1887	2045	2190	24"	22"
60"	502	545	625	718	795	895	982	1109	1156	1265	1312	1409	1485	1727	1969	2097	2287	2479	24"	24"
66"	547	618	681	787	888	953	1089	1196	1273	1353	1474	1574	1686	1876	2147	2322	2533	2706	36"	26"
72"	599	655	729	809	912	1066	1198	1338	1375	1474	1600	1690	1853	2015	2322	2479	2726	2970	36"	29"
78"	664	700	793	869	979	1133	1260	1388	1474	1613	1729	1853	1939	2224	2488	2670	2947	3171	36"	31"
84"	715	782	889	966	1096	1217	1375	1531	1602	1723	1853	1976	2105	2395	2678	2890	3204	3468	36"	34"
90"	776	852	942	1048	1157	1299	1451	1643	1717	1831	1987	2103	2239	2553	2860	3107	3394	3701	40"	36"
96"	808	884	994	1111	1260	1401	1569	1760	1842	1965	2142	2255	2410	2720	3083	3331	3649	3954	40"	38"
102"	854	942	1055	1176	1338	1487	1669	1868	1987	2114	2287	2408	2601	2934	3292	3558	3906	4243	50"	41"
108"	897	994	1131	1252	1427	1589	1794	1993	2082	2240	2417	2531	2737	3126	3504	3761	4105	4470	50"	43"
114"	945	1036	1176	1323	1507	1684	1870	2119	2201	2346	2544	2678	2884	3271	3694	3954	4337	4730	72"	46"
120"	1003	1096	1256	1397	1584	1742	1965	2231	2337	2477	2685	2836	3059	3470	3872	4170	4607	5009	72"	48"
126"	1040	1141	1312	1464	1675	1850	2078	2350	2454	2613	2827	2974	3221	3656	4094	4386	4832	5260	72"	50"

Chart B		Olympic Ridge - Item Code T2																Wand	Cord
WIDTH TO:	24"	28"	32"	36"	42"	48"	54"	60"	66"	72"	78"	84"	90"	96"	108"				
30"	312	379	431	452	496	540	598	719	746	790	935	1004	1096	1154	1215	24"	12"		
36"	372	439	477	498	562	606	688	795	839	910	1035	1091	1190	1265	1338	24"	14"		
42"	408	489	521	558	636	677	788	884	903	1016	1133	1211	1328	1405	1466	24"	17"		
48"	447	533	575	608	686	749	874	995	1064	1152	1265	1359	1460	1654	1802	24"	19"		
54"	493	581	629	665	759	805	956	1085	1129	1290	1426	1531	1648	1815	1980	36"	22"		
60"	540	646	696	732	838	907	1058	1194	1271	1407	1531	1690	1846	2007	2135	36"	24"		
66"	579	705	757	815	893	972	1165	1305	1393	1522	1717	1825	2022	2229	2403	36"	26"		
72"	638	770	828	866	968	1058	1248	1409	1485	1616	1809	1972	2185	2340	2486	36"	29"		
78"	692	807	843	912	1004	1114	1273	1459	1545	1729	1959	2089	2242	2482	2654	48"	31"		
84"	746	895	930	976	1064	1196	1336	1489	1698	1850	2097	2239	2576	2752	2875	48"	34"		
90"	792	935	970	997	1131	1244	1436	1566	1769	1940	2162	2365	2639	2791	2990	N/A	36"		
96"	849	983	1008	1054	1165	1324	1474	1673	1886	2081	2365	2584	2902	2978	3187	N/A	38"		
102"	885	1027	1054	1089	1232	1382	1625	1765	1989	2187	2526	2695	2944	3113	3289	N/A	41"		
108"	947	1079	1123	1173	1294	1482	1650	1896	2118	2455	2633	2860	3141	3264	3465	N/A	43"		
114"	985	1144	1179	1229	1367	1543	1759	1961	2208	2469	2756	2982	3312	3486	3707	N/A	46"		

Chart C		Olympic Ridge - Item Code T2																Wand	Cord
WIDTH TO:	24"	28"	32"	36"	42"	48"	54"	60"	66"	72"	78"	84"	90"	96"	108"				
30"	333	410	464	489	535	586	640	772	797	845	1006	1077	1179	1236	1303	24"	12"		
36"	399	475	512	531	604	663	740	853	903	976	1108	1173	1271	1357	1436	24"	14"		
42"	439	525	565	596	680	740	845	945	968	1092	1211	1301	1424	1508	1575	24"	17"		
48"	481	573	613	650	736	818	935	1060	1137	1236	1363	1457	1568	1775	1928	24"	19"		
54"	529	621	673	713	815	882	1023	1165	1211	1382	1529	1643	1771	1940	2120	36"	22"		
60"	579	694	744	786	897	991	1133	1276	1365	1510	1643	1811	1984	2152	2288	36"	24"		
66"	627	759	815	876	958	1062	1252	1397	1493	1629	1842	1961	2168	2394	2572	36"	26"		
72"	684	824	885	928	1039	1163	1336	1510	1593	1733	1938	2114	2346	2509	2670	36"	29"		
78"	738	868	903	976	1075	1223	1365	1566	1658	1848	2103	2242	2405	2662	2844	48"	31"		
84"	799	960	995	1045	1135	1307	1436	1597	1821	1984	2252	2403	2764	2952	3082	48"	34"		
90"	845	1004	1043	1073	1215	1361	1537	1681	1897	2083	2319	2536	2831	2990	3208	N/A	36"		
96"	889	1060	1102	1160	1288	1460	1650	1790	2020	2229	2538	2769	3109	3197	3421	N/A	38"		
102"	941	1119	1161	1223	1355	1539	1740	1894	2137	2346	2708	2890	3153	3341	3527	N/A	41"		
108"	991	1181	1221	1284	1424	1620	1830	2028	2271	2630	2827	3061	3367	3498	3714	N/A	43"		
114"	1043	1240	1280	1347	1491	1698	1919	2103	2369	2645	2955	3197	3550	3739	3975	N/A	46"		
	2 Ladders			3 Ladders				4 Ladders				5 Ladders				6 Ladders			

2 or 3 on 1 head rail is recommended for blind sizes in the shaded area.

Warranty does not apply to these sizes.

20% surcharge for 2 1/2" Bass Wood products.

Pricing Charts

2" Horizontals

Chart D																	Olympic Ridge - Item Code T2										
WIDTH TO:	24"	28"	32"	36"	42"	48"	54"	60"	66"	72"	78"	84"	90"	96"	108"	Wand	Cord										
30"	352	428	485	508	559	609	672	809	840	888	1053	1131	1234	1298	1367	24"	12"										
36"	418	493	537	560	632	682	774	896	946	1025	1165	1227	1340	1423	1506	24"	14"										
42"	460	551	587	628	716	761	886	994	1017	1144	1275	1364	1494	1581	1650	24"	17"										
48"	503	599	647	684	772	844	984	1119	1198	1296	1423	1529	1643	1862	2028	24"	19"										
54"	555	653	707	749	855	905	1077	1221	1271	1452	1604	1724	1855	2043	2228	36"	22"										
60"	609	726	784	824	942	1021	1190	1344	1431	1583	1724	1903	2078	2259	2404	36"	24"										
66"	651	793	851	917	1005	1094	1312	1469	1568	1712	1934	2053	2276	2509	2704	36"	26"										
72"	718	867	932	975	1090	1190	1404	1585	1672	1818	2036	2219	2459	2635	2798	36"	29"										
78"	778	909	949	1027	1131	1254	1433	1641	1739	1945	2205	2352	2523	2793	2987	48"	31"										
84"	840	1007	1046	1098	1198	1346	1504	1676	1910	2082	2359	2519	2898	3097	3236	48"	34"										
90"	892	1053	1092	1121	1273	1400	1616	1762	1991	2182	2432	2662	2970	3141	3365	N/A	36"										
96"	955	1107	1134	1186	1312	1491	1658	1884	2122	2342	2662	2908	3266	3351	3588	N/A	38"										
102"	996	1156	1186	1225	1387	1556	1830	1988	2240	2461	2843	3033	3313	3503	3702	N/A	41"										
108"	1065	1215	1263	1319	1456	1668	1857	2134	2384	2764	2964	3218	3536	3673	3900	N/A	43"										
114"	1109	1288	1327	1383	1539	1737	1980	2207	2484	2779	3103	3357	3727	3923	4171	N/A	46"										

Chart E																	Olympic Ridge - Item Code T2										
WIDTH TO:	24"	28"	32"	36"	42"	48"	54"	60"	66"	72"	78"	84"	90"	96"	108"	Wand	Cord										
30"	387	470	533	559	614	670	740	890	924	976	1159	1244	1358	1427	1504	24"	12"										
36"	460	543	591	616	695	749	851	986	1040	1127	1283	1350	1475	1566	1656	24"	14"										
42"	507	607	647	691	788	838	975	1094	1119	1258	1402	1500	1645	1739	1816	24"	17"										
48"	553	659	713	753	849	928	1082	1231	1317	1425	1566	1681	1806	2049	2230	24"	19"										
54"	611	718	778	824	940	996	1184	1342	1398	1597	1764	1897	2040	2248	2452	36"	22"										
60"	670	799	863	907	1036	1123	1310	1479	1573	1741	1897	2093	2286	2484	2644	36"	24"										
66"	716	872	936	1009	1105	1204	1442	1616	1724	1884	2126	2259	2504	2760	2974	36"	26"										
72"	790	953	1025	1073	1200	1310	1545	1743	1839	1999	2240	2440	2706	2898	3078	36"	29"										
78"	855	1000	1044	1129	1244	1379	1575	1805	1912	2140	2427	2586	2775	3072	3286	48"	31"										
84"	924	1107	1150	1208	1317	1481	1654	1843	2101	2290	2596	2771	3189	3407	3559	48"	34"										
90"	980	1159	1202	1233	1400	1541	1778	1939	2190	2400	2675	2927	3266	3455	3702	N/A	36"										
96"	1052	1219	1248	1306	1442	1639	1824	2072	2334	2577	2927	3199	3594	3686	3946	N/A	38"										
102"	1096	1271	1306	1348	1525	1712	2013	2186	2463	2708	3128	3338	3644	3854	4071	N/A	41"										
108"	1171	1337	1390	1452	1602	1835	2041	2348	2623	3041	3261	3540	3890	4041	4291	N/A	43"										
114"	1221	1417	1460	1521	1693	1910	2178	2429	2733	3056	3413	3692	4100	4316	4589	N/A	46"										

Chart F																	Summit Woods- Item Code WB										
WIDTH TO:	24"	30"	36"	42"	48"	54"	60"	66"	72"	78"	84"	96"	108"	120"	Wand	Cord											
36"	521	603	692	757	802	970	1080	1110	1140	1268	1368	1580	1715	1872	24"	14"											
42"	575	657	765	839	892	1087	1202	1215	1286	1426	1542	1785	1943	2121	24"	17"											
48"	626	725	836	926	990	1197	1317	1371	1437	1578	1728	2012	2208	2426	24"	19"											
54"	686	798	913	1012	1080	1319	1425	1526	1616	1772	1914	2216	2410	2632	24"	22"											
60"	763	866	995	1095	1178	1445	1554	1654	1760	1924	2082	2410	2625	2868	36"	24"											
66"	817	929	1061	1175	1294	1578	1695	1815	1937	2099	2265	2714	2974	3282	36"	26"											
72"	896	997	1139	1273	1407	1707	1848	1929	2053	2229	2414	2808	3063	3352	36"	29"											
78"	922	1014	1174	1313	1452	1760	1899	1989	2197	2382	2581	2992	3262	3567	36"	31"											
84"	994	1085	1240	1409	1556	1851	1938	2129	2360	2543	2750	3192	3478	3804	48"	34"											
90"	1063	1150	1314	1485	1644	1960	2050	2263	2500	2671	2930	3406	3737	4104	48"	36"											
96"	1099	1191	1354	1554	1722	2060	2185	2415	2660	2867	3107	3608	3933	4303	N/A	38"											
102"	1153	1256	1429	1654	1834	2189	2324	2557	2827	3036	3297	3834	4186	4584	N/A	41"											
108"	1212	1305	1501	1733	1924	2300	2436	2696	2974	3188	3458	4022	4390	4807	N/A	43"											
114"	1264	1371	1587	1832	2023	2418	2570	2831	3135	3358	3639	4228	4612	5047	N/A	46"											
	2 Ladders			3 Ladders				4 Ladders				5 Ladders			6 Ladders												

2 or 3 on 1 head rail is recommended for blind sizes in the shaded area.

Warranty does not apply to these sizes.

20% surcharge for 2 1/2" Bass Wood products.

Pricing Charts

← WIDTH TO →

2" Horizontals

↑ HEIGHT TO ↓

Chart G		Summit Woods - Item Code													WB	
WIDTH TO:	24"	30"	36"	42"	48"	54"	60"	66"	72"	78"	84"	96"	108"	120"	Wand	Cord
36"	619	692	776	822	874	991	1169	1275	1353	1543	1715	2150	2410	2714	24"	14"
42"	682	757	855	914	972	1110	1303	1399	1524	1736	1932	2428	2724	3070	24"	17"
48"	736	834	935	1000	1075	1225	1430	1577	1706	1924	2170	2741	3095	3503	24"	19"
54"	815	914	1018	1096	1169	1349	1551	1756	1915	2158	2400	3019	3386	3816	24"	22"
60"	897	995	1112	1188	1276	1478	1683	1903	2081	2346	2605	3285	3684	4154	36"	24"
66"	970	1071	1190	1278	1405	1612	1842	2089	2290	2559	2840	3697	4171	4740	36"	26"
72"	1062	1148	1273	1382	1528	1746	2007	2216	2426	2714	3022	3820	4291	4844	36"	29"
78"	1091	1167	1309	1420	1574	1800	2060	2290	2601	2902	3231	4071	4570	5155	36"	31"
84"	1179	1248	1382	1526	1687	1894	2104	2449	2794	3097	3448	4351	4885	5512	48"	34"
90"	1261	1322	1470	1614	1784	2007	2227	2605	2961	3258	3672	4636	5234	5923	48"	36"
96"	1305	1368	1512	1685	1865	2106	2371	2777	3149	3492	3896	4910	5518	6227	N/A	38"
102"	1367	1445	1600	1796	1989	2240	2522	2940	3348	3701	4128	5221	5870	6630	N/A	41"
108"	1436	1503	1677	1880	2089	2352	2645	3097	3519	3877	4333	5474	6158	6956	N/A	43"
114"	1497	1575	1775	1988	2202	2476	2791	3256	3711	4090	4558	5754	6464	7296	N/A	46"

Chart H		Sophistique- Item Code											LX2
WIDTH TO:	24"	32"	36"	42"	48"	54"	60"	66"	72"	78"	84"	96"	
36"	522	611	666	714	834	965	1057	1153	1256	1304	1628	1928	
42"	573	673	735	714	937	1074	1195	1311	1366	1473	1838	2134	
48"	632	731	807	800	1033	1181	1322	1476	1507	1648	2056	2403	
54"	690	796	889	875	1133	1280	1459	1613	1689	1819	2271	2673	
60"	741	862	954	965	1239	1383	1576	1709	1836	1991	2485	2900	
66"	810	927	1033	1050	1363	1521	1682	1871	2132	1819	2271	3085	
72"	862	989	1112	1164	1479	1655	1840	2008	2279	2293	2862	3359	
78"	889	1020	1147	1263	1510	1703	1915	2142	2454	2478	3093	3642	
84"	947	1085	1225	1298	1603	1734	2060	2266	2626	2657	3316	3916	
90"	1002	1184	1304	1390	1685	1836	2207	2423	2801	2849	3556	4198	
96"	1044	1256	1366	1479	1771	2262	2355	2588	2976	3034	3787	4481	
102"	1098	1315	1445	1534	1885	2077	2506	2739	3151	3227	4027	4755	
108"	1133	1390	1517	1637	1981	2183	2653	2911	3330	3419	4267	5038	
114"	1191	1445	1606	1727	2084	2307	2798	3069	3501	3604	4498	5321	

Chart I		Sophistique - Item Code											LX2
WIDTH TO:	24"	32"	36"	42"	48"	54"	60"	66"	72"	78"	84"	96"	
36"	753	890	1043	1134	1216	1419	1643	1800	1963	2141	2223	2219	
42"	844	977	1144	1251	1216	1597	1831	2034	2233	2329	2507	2455	
48"	905	1078	1246	1373	1363	1760	2014	2253	2518	2569	2808	2763	
54"	997	1175	1358	1516	1490	1933	2182	2487	2752	2879	3103	3076	
60"	1088	1261	1470	1628	1643	2111	2355	2685	2914	3128	3392	3337	
66"	1180	1378	1582	1760	1790	2324	2589	2869	3189	3408	3687	3547	
72"	1302	1470	1684	1897	1984	2523	2818	3133	3423	3632	3906	3864	
78"	1348	1516	1739	1953	2151	2574	2899	3265	3652	3886	4221	4190	
84"	1439	1612	1846	2090	2212	2731	2955	3509	3860	4181	4527	4503	
90"	1531	1709	2019	2223	2370	2874	3128	3759	4130	4476	4857	4828	
96"	1607	1780	2141	2329	2523	3016	3326	4013	4410	4771	5173	5154	
102"	1673	1933	2238	2462	2614	3209	3540	4272	4669	5071	5498	5471	
108"	1760	2029	2370	2584	2792	3377	3718	4522	4959	5371	5824	5792	
114"	1836	2136	2462	2736	2940	3550	3932	4766	5229	5676	6144	6118	
	2 Ladders			3 Ladders				4 Ladders				5 Ladders	

2 or 3 on 1 head rail is recommended for blind sizes in the shaded area.

Warranty does not apply to these sizes.

20% surcharge for 2 1/2" Bass Wood products.

Samples



2" Aluminum

Our complete collection of 2" Aluminum.
Select colors match 1" Aluminum.
19 Different Color Sku's
Sku # SAI006
\$5.00



Olympic 2" & 2 1/2"

Our complete collection of Faux Wood.
25 Different Sku's
Sku # SAI003
\$10.00

COMING SOON

Sophistique 2" & 2 1/2"

Our complete collection of 2" Fabric.
32 Different Color Sku's
Sku # SAI033
Coming Soon



2" Decorative Tape

Our complete collection of 2" Decorative Tape.
24 Different Color Sku's
Sku # SAI007
\$10.00



Summit Woods 2" & 2 1/2"

Our complete collection of 2" bass wood.
20 Different Color Sku's
Sku # SAI002
\$5.00

2" Horizontals

Measuring Instructions

2" Horizontals

Tools needed:

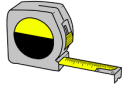

Tape Measure



Pencil



Order Form
Cut Out Diagram
Angled Diagram

Follow lettered guides for correct measuring and cut-outs.

Please Note:

- When Measuring for an inside mount, measure in three different places and take the smallest measurement. This ensures that your shade will fit inside the window sill.
- Fill out appropriate Cut-Out or Angled Shade diagram order form to make sure your blind is ordered correctly.
- When measuring for a Cut-Out, think of the blind in a flat tilted up or down position. This will allow for adequate space around your cut out.

Standard Shade:

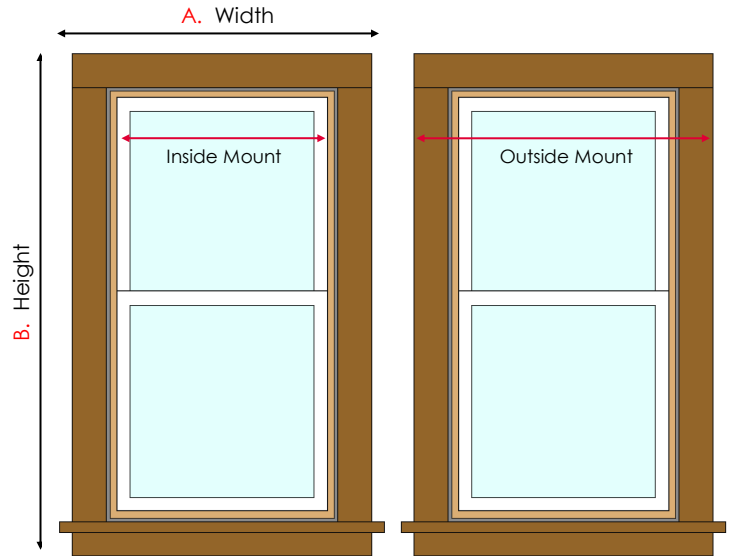

Side Center Notch

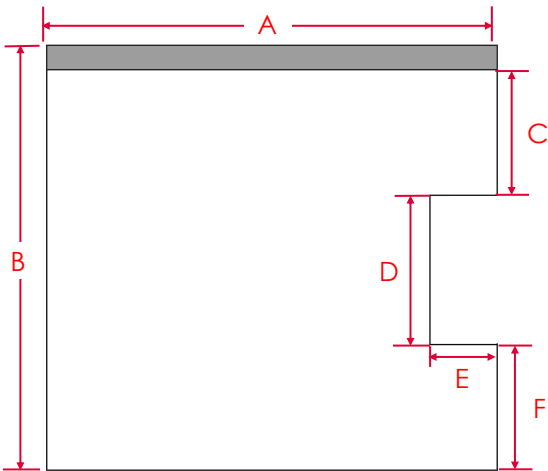

Angled

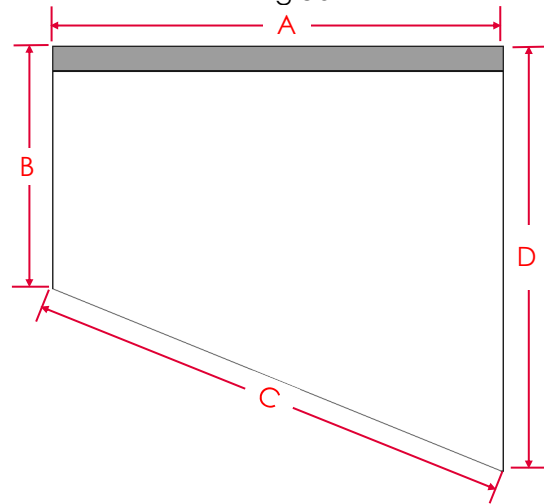

Side Bottom Notch

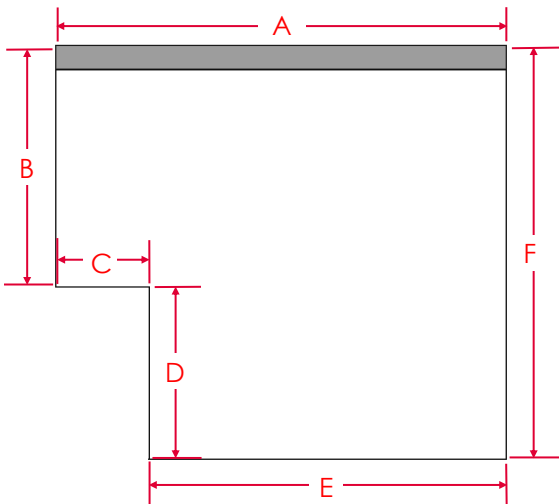

Notch & Angled Minimums & Maximums

Measurement	A		B		C		D**		E		F	
	Min	Max	Min	Max	Min	Max	Min	Max	Min	Max	Min	Max
Side Bottom	*	*	3"	*	1/2"	6"	2"	*	3"	*	*	*
Side Center	*	*	*	*	3"	*	2"	*	1/2"	6"	*	*
Angled	*	*	*	*	*	*	*	*	N/A	N/A	N/A	N/A

* Reference chosen products Minimums & Maximums

Install Instructions

2" Horizontals

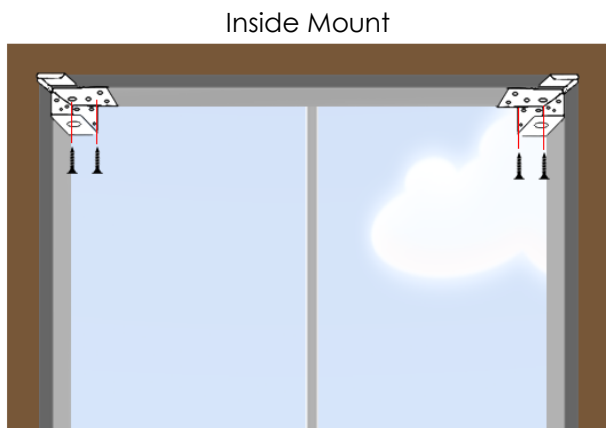
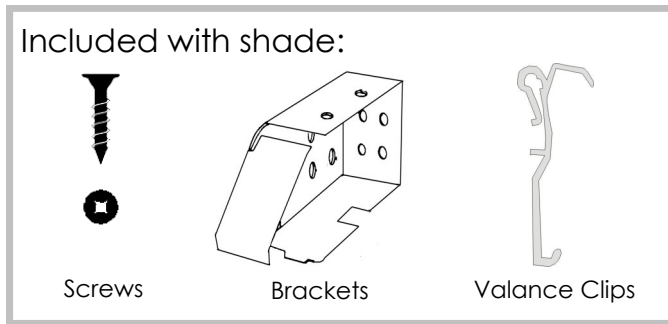
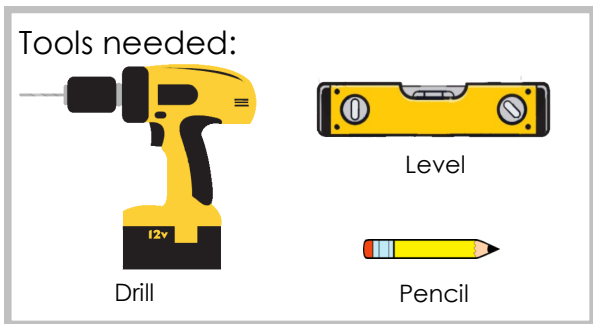

Inside Mount

1. Make sure the top of the sill is level and clear of anything that could be in the way. Center the blind inside the window casing.
2. Make pencil marks below the headrail on each end, for an inside mount the box brackets will be placed on these marks.
3. Attach the two end brackets flush against the sides of the window casement.

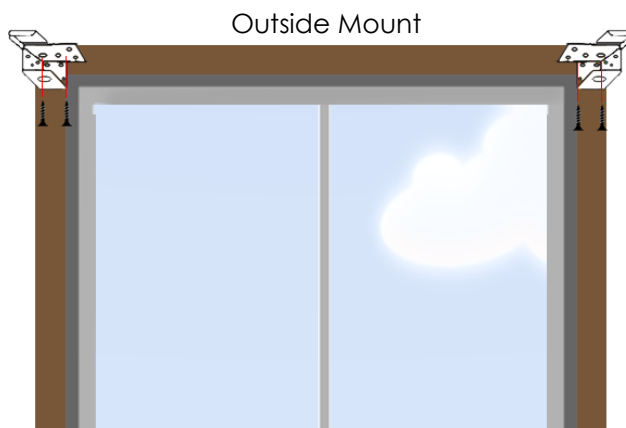

Outside Mount

1. Position blind in desired area. Make sure the headrail is level.
2. Make pencil marks below the headrail on each end, for an inside mount the box brackets will be placed on these marks. Also make a mark 1/4" to the outside of the headrail end marks.
3. Align the outside of each bracket with the outer marks and attach.

Installation

After brackets are installed, follow these directions:

1. Snap the valance clips over the front lip of the headrail before putting the blind into the box brackets, keep in mind to position the clips away from the ladder and cords.
2. Insert the headrail into the box brackets; if a center support bracket is being used, make sure that is connected with the headrail as well.
3. Close the swivel cover on the box bracket to lock the headrail into place.
4. Snap valance into clips.

Center Support Brackets

If your blind is over 60" wide, you have been supplied center support brackets. Center supports are meant to be spaced evenly, and in a place where they will not interfere with any lift cords or slat ladders. Center support brackets should be mounted level with the left and right mounting box brackets.

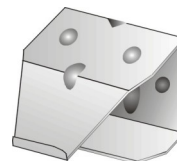

2" General Warranty

2" Horizontals

Statement of Warranty

A&I Manufacturing is proud to extend a Limited Lifetime Warranty on our 2" Horizontals. Each product is warranted to the original residential retail purchaser to be free from manufacturing defects in materials and workmanship as long as the product remains in the original window. This Limited Lifetime Warranty is not valid for products used for commercial use, rentals, and non-residential use in which cases there is a Limited 1 Year Warranty.

Somfy Motorization offers a 5 year warranty. Motorization offered from Somfy will be free from defects in materials and workmanship for a period of five years from the date of purchase. Batteries do not come with a warranty. Motor warranty can be voided if incorrect type of batteries are used to power the motor.



A&I proudly offers a 5 Year Limited Lifetime Warranty on all cords and components for all of our 2" Horizontal product lines for residential use.

Warranty Exclusions

This Limited Lifetime Warranty does not cover any product that fails due to:

- Accidents
- Alteration
- Misuse
- Abuse/Extraordinary Use
- Misapplication
- Improper handling
- Improper Installation
- Any conditions caused by normal wear and tear over the passage of time
- Cleaning
- Loss of color intensity
- Exposure to salt-air, or extreme heat
- Damage from insects or pets
- Damage from water
- Yellowing or cracking of plastic parts with the passage of time
- Warping of slats

Cord & Components Warranty

This Limited Lifetime Warranty **does not** cover transportation costs to and from the retailer, costs of removal, re-measure, or reinstallation of product, or any incidental or consequential damages.

Warranty Remedies

If an A&I Manufacturing product is found to be defective in materials or workmanship, we will, at our discretion: repair, replace or refund the cost of the product which fails to conform to this Limited Lifetime Warranty.

Colors do vary from lot to lot and may not exactly match sample swatch or previously purchased product. Discontinued items or colors will be replaced with the closest equivalent available. This shall be the sole remedy under this Limited Lifetime Warranty.

To Obtain Service:

Please return product, along with your original sales receipt or work order, to the original retailer from which the product was purchased and they will return the product to A&I Manufacturing.



**2" Horizontals
ORDER FORM**

Please Fill Out Completely
& Print Clearly

Print Date: 4/17/2024

Sold To:

Ship To:

PO #:
Side Mark:
Quote #:
Date
Ordered By:
Phone #:
Fax #:
Email:
Account #:

Room Codes	Room	Room Codes	Room
ENT	Entry	BTH	Bath
LV	Living Room	MBTH	Master Bath
KT	Kitchen	GA	Garage
DR	Dinning Room	LDR	Laundry
BR#	Bedroom (1, 2, 3)	FR	Family Room
MBR	Master Bed Room	OF	Office

- A&I Delivery
- Will Call
- UPS
- Freight

Item Code	Corded Style	Max Width	Max Height	Max Width	Max Height	Max Width	Max Height	Max Width	Max Height	Max Width	Max Height	Max Width	Max Height	Max Width	Max Height	Max Width	Max Height	
A2	Aluminum Standard	108"	120"	45 sq. ft.	72"	78"	45 sq. ft.	72"	78"	45 sq. ft.	72"	78"	45 sq. ft.	72"	78"	45 sq. ft.	72"	78"
T2	Olympic Ridge	108"	120"	120 sq. ft.	72"	78"	120 sq. ft.	72"	78"	120 sq. ft.	72"	78"	120 sq. ft.	72"	78"	120 sq. ft.	72"	78"
WB	Summit Wood	96"	120"	80 sq. ft.	72"	78"	80 sq. ft.	72"	78"	80 sq. ft.	72"	78"	80 sq. ft.	72"	78"	80 sq. ft.	72"	78"
B25	Cascadia	122"	120"	122 sq. ft.	72"	78"	122 sq. ft.	72"	78"	122 sq. ft.	72"	78"	122 sq. ft.	72"	78"	122 sq. ft.	72"	78"
LX2	Sophistic	120"	120"	45 sq. ft.	72"	78"	45 sq. ft.	72"	78"	45 sq. ft.	72"	78"	45 sq. ft.	72"	78"	45 sq. ft.	72"	78"

Line #	Room Code	Item Code	Qty	Width	Height	Number	Color		Mount	HLD/		Tilt Style		Controls		Control Length			Tape		Notes	Price		
							IS	OS		DWN	W	C	Tilt	Lift	Tilt	Motor	Tilt	Lift	NO.	Name				
1																								
2																								
3																								
4																								
5																								
6																								
7																								
8																								
9																								
10																								
11																								
12																								
13																								
14																								
15																								

Additional Notes:	Rev/used 9/22/16
Sub-Total	
Surcharges/ Freight	
Total	

Customer Service: 800-283-6112
Fax: 800-276-1773

Credit Card Authorization Signature:
Orders cannot be cancelled once production has started. All products are custom made and are not subject to change or cancellation once production has

Or visit our extensive website: www.a-manufacturing.net